

**Notice:**

Motor shaft length & electrical performance could be customized according to customer requirements.

■ Features

- High efficiency and energy saving
- Low temperature rise and long service life
- Wide speed range, stepless speed regulation
- Multiple security protection
Equipped with locked-rotor, over-current, over-voltage, and under-voltage protection, making it safer and more reliable to use.
- The speed does not decay, zero % speed attenuation rate.
- Signal function available
- Quiet, no noise, low EMI

■ Applications

- Air purifier
- Circulation fan
- Floor fan
- Without blade fan
- Smart home
- Intelligent robot
- Fascial massaging gun
- Massager
- Customized according to customer needs

■ Characteristics**Phase:**

3 phases

Rotation Direction:

CW rotation with shaft side view

Insulation Class:

E class (Except lead wires)

Operating Mode:

Continuous

Audible noise:

Ball bearing: < 45dB

Oil bearing: < 55dB

Life time:

Ball bearing: >10,000 hours

Oil bearing: >3,000 hours

Storage temperature range:

-20~70 °C

Operating temperature range:

Environment -20~50°C

Power transistor 105°C MAX

Bearing 80°C MAX

Coil 110°C MAX

Operating & storage humidity range:

30 ~ 95%RH No condensation

■ Mechanical Characteristics

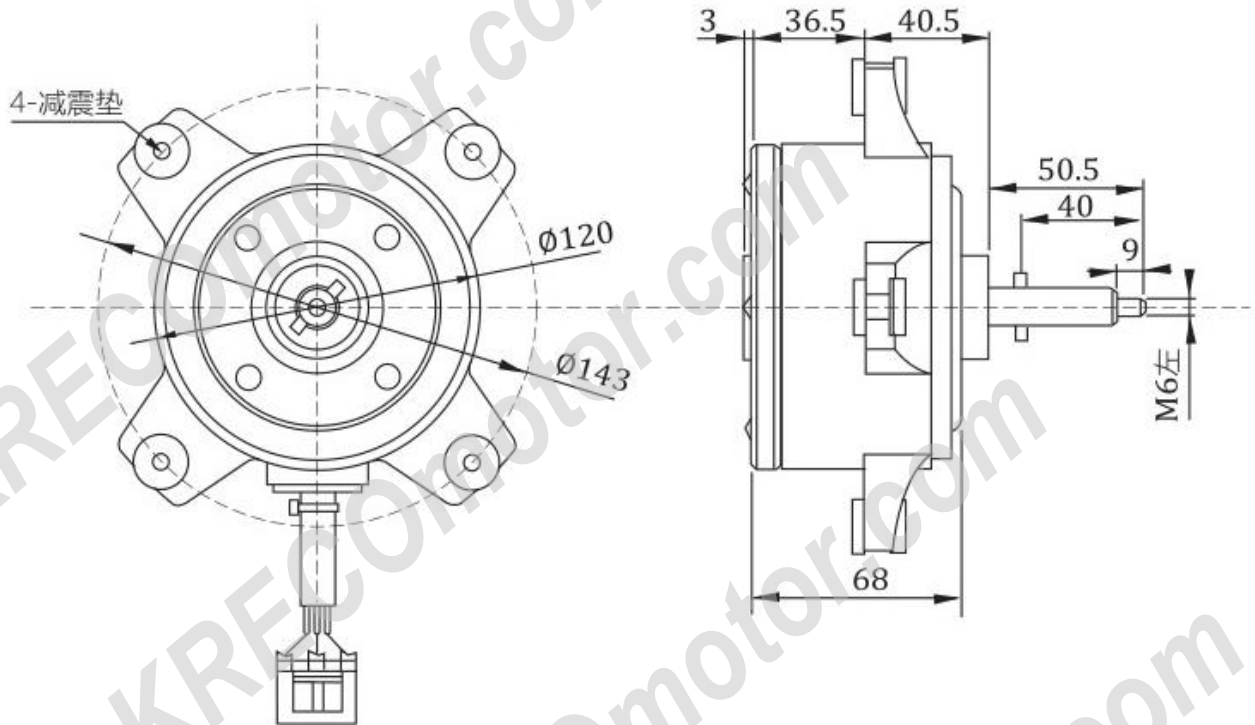

■ Typical Performance/Specification

Model	Rated Voltage	No-load Speed	No-load Current	Load Speed	Load Current	Load Torque	Driving Methods	Power
BM120x	DC310v	1500rpm	0.1A max	1050rpm	0.5A max	170mN.m	PWM (1-15k) VSP(0.5-4.7V)	120W

- (1) The x in the model no. represents the voltage / power / rpm, which are customized according to customer requirements.
- (2) If possible, original application load/device (e.g. fan blade) part and control panel PCBA are required before designing, please send to our address.
- (3) Control methods could be with Hall Sine Wave, with Hall FOC, without Hall FOC, PWM etc.
- (4) Safety model number differs from the order number, part number, and shape number as per respective OEM/ODM factories.
- (5) Data in this typical specification sheet is for reference, voltage, rated torque, speed, current, power, shaft extension feature, and dimension could be designed according to customer requirement.

Kreco is not responsible for any error, and reserves the right to make changes without notice. Please visit our website at <http://krecomotor.com> for the most up-to-date specifications and contact information.